

RC RODCRAFT®

Pnevmatsko orodje in delavniška oprema



RC RODCRAFT®

Zastopnik: *PODRŽAJ & CO., d.n.o.*

Cene za končnega uporabnika brez DDV. Pridržujemo si pravico do tehničnih sprememb, sprememb v barvi in tiskarskih napak brez predhodnega obvestila. www.podrzaj-rodcraft.si

KATALOG

2026/27

TABLE OF CONTENT

Product Highlights	Page 3
Rodcraft pneumatic tools	Pages 4 – 5
Impact wrenches	Pages 6 – 9
Torque wrenches & sockets	Page 10
Ratchets	Page 11
Rodflex-Tools	Page 12
Mini tools	Page 13
Drills & screwdrivers	Pages 15 – 16
Chisel hammers & needle scalers	Pages 17 – 17
Grinders & Polishers	Pages 19 – 22
MBX Multi Sander	Page 23
Special tools & cutting	Page 24
Riveters	Page 25
Windshield Tools	Page 26
Other pneumatic tools	Page 27
Workshop Equipment	Pages 28 – 29
Car jacks	Pages 30 – 32
Workshop presses	Page 33
Air line accessories	Pages 34 – 35

OUR LATEST PRODUCT HIGHLIGHTS

More Details to explore on the innerpages

Pneumatic impact wrench 1/2"

Model RC2277

More details page 6



MBX Multi Sander

Model RC7095K

More details
page 23



Orbital sander

Model

RC7705V6

More details
page 19



Car jack

Model RH316

More details page 30



For product updates and latest news please check our Website.
WWW.RODCRAFT.COM

Rodcraft pneumatic tools – for professional repair and assembly work

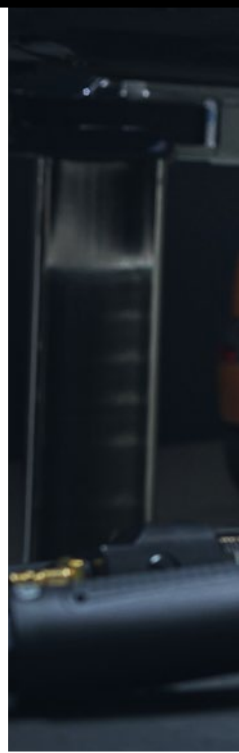

Rodcraft stands for high-quality tools that perform reliably. Our range includes impact wrenches for strong fastening, ratchets and wrenches for working in confined spaces, scalers for efficient removal of rust and scale, and various grinders for precise grinding and deburring tasks.



ny pneumatic tools
e includes powerful
tenings, ratchet
ed spaces, needle
rust and coatings,
e grinding and



Pnevmatski udarni vijačnik 1/2"
Model RC22277
 Item no.: 8951000349

THE BEAST

Ekstremna vzdržljivost: najbolj kvalitetni materiali v kombinaciji z odličnim dizajnom, ki združuje celotno Rodcraftovo znanje. 3 stopnje zategovanja, ena maksimalna stopnja odvijanja.

HIGHLIGHT-PRODUCT



€ 215,00

Pneumatic impact wrench 3/8"
Model RC2177
 Item no.: 8951000043

Ergonomic and lightweight tool with very good weight distribution. Non-slip and shock-absorbing handle, high performance for quick disassembly with low compressed air requirement.

Compact design for confined spaces. Durable DUOPACT hammer mechanism.



€ 239,00

Pneumatic impact wrench 1/2"
Model RC2203
 Item no.: 8951000387

The RC2203 is known for its ultra-compact design and its high performance. It is the best choice for users working in hard-to-reach places and looking for an excellent power-to-weight ratio.



€ 175,00

Pneumatic impact wrench 1/2"
Model RC2205
 Item no.: 8951000085

The popular classic. One-hand operation with left/right switch and 4-stage power regulation when tightening. Full power when loosening - max. 800 Nm. Attachment option for sound-absorbing hose.



€ 149,00

Pneumatic impact wrench 1/2"
Model RC2267
 Item no.: 8951000044

Ergonomic and lightweight tool with very good weight distribution. Non-slip and shock-absorbing handle, high performance for quick disassembly with low compressed air requirement. Compact design for confined spaces.



€ 239,00

Pneumatic impact wrench 1/2"
Model RC2266
 Item no.: 8951000436

The RC2266 1/2" impact wrench is impressive with its versatility, its excellent price-performance ratio and the well-known RODCRAFT quality.



€ 155,00

Recommended accessories
SOCKET SET
 See page 10



Angle impact wrench 1/2"

Model RC2235

Item no.: 8951000286

Low profile angle impact wrench with ergonomic grip. Ultra-compact head (only 50 mm). Durable with reinforced head and helical gearing.

High sensitivity pusher, torque adjustment, easy forward/reverse switching.

€ 379,00



Pneumatic impact wrench 3/4"

Model RC2377

Item no.: 8951000045

Ergonomic tool with very good weight distribution (best weight/power ratio in its class). Non-slip and shock-absorbing handle and durable DUOPACT hammer mechanism.

€ 559,00



Pneumatic impact wrench 3/4"

Model RC2315

Item no.: 8951077130

All-rounder for every application. DUOPACT hammer mechanism, 3-stage power reduction when tightening. Handle with insulating rubber coating.

€ 359,00



MODEL	RC2277	RC2203	RC2267	RC2205	RC2266	RC2235	RC2177	RC2377	RC2315
Item number	8951000349	8951000387	8951000044	8951000085	8951000436	8951000286	8951000043	8951000045	8951077130
Output drive size	1/2"	1/2"	1/2"	1/2"	1/2"	1/2"	3/8"	3/4"	3/4"
Max. loosening torque	1,950 Nm	1,254 Nm	1,150 Nm	800 Nm	1,600 Nm	450 Nm	950 Nm	2,200 Nm	1,700 Nm
Max. torque in reverse	1,300 Nm	650 Nm	660 Nm	580 Nm	1,000 Nm	300 Nm	580 Nm	1,950 Nm	1,500 Nm
Working torque range (forward)	60–900 Nm	90–450 Nm	22–486 Nm	34–420 Nm	140–750 Nm	60–220 Nm	37–258 Nm	234–1,391 Nm	177–1,100 Nm
Free speed	8,200 rpm	10,500 rpm	10,200 rpm	7,800 rpm	9,000 rpm	7,400 rpm	8,200 rpm	5,760 rpm	5,600 rpm
Impact mechanism	DUOPACT	Twin Hammer	DUOPACT	Pin clutch	DUOPACT	Jumbo hammer	DUOPACT	DUOPACT	DUOPACT
Air intake thread size	1/4"	1/4"	1/4"	1/4"	1/4"	1/4"	1/4"	3/8"	3/8"
Noise level	94 dB(A)	90 dB(A)	93 dB(A)	87.4 dB(A)	96.4 dB(A)	97 dB(A)	90 dB(A)	96.8 dB(A)	91.1 dB(A)
Length	194 mm	115 mm	164 mm	200 mm	185 mm	341 mm	164 mm	221 mm	242 mm
Weight	2 kg	1.1 kg	1.25 kg	2.4 kg	2.18 kg	1.85 kg	1.25 kg	3.5 kg	4.7 kg

Pneumatic impact wrench 1"

Model RC2405

Item no.: 8951000075



The RC2377/RC2405 range of impact wrenches is the perfect companion for vehicle and tire services with their excellent power-to-weight ratio and ergonomics.

€ 615,00

Pneumatic impact wrench 1"

Model RC2437Xi

Item no.: 8951000068



The RC2437Xi range contains the perfect 1" impact wrenches for workshops looking for low weight and high torque.

€ 940,00

Pneumatic impact wrench 1"

Model RC2461

Item no.: 8951000354

Short anvil



Take advantage of the benefits of the 1" RC2461 and RC2471 impact wrenches.

They enable the operator to easily loosen wheel nuts on commercial vehicles.

These 1" impact wrenches offer high reliability thanks to their durable impact mechanism and metal housing.

Pneumatic impact wrench 1"

Model RC2471

Item no.: 8951000355

Long anvil



€ 599,00

€ 599,00

Pneumatic impact wrench 1"

Model RC2457Xi

Item no.: 8951000135

Short anvil



The RC2457Xi and RC2477Xi models are perfect for tightening and loosening wheel nuts on commercial vehicles.

The low weight and the compact design also offer you a high level of comfort in your daily work and ultimately increase your productivity.

Pneumatic impact wrench 1"

Model RC2477Xi

Item no.: 8951000046

Long anvil



€ 897,00

€ 854,00

MODEL	RC2405	RC2437Xi	RC2461	RC2471	RC2457Xi	RC2477Xi
Item number	8951000075	8951000068	8951000354	8951000355	8951000135	8951000046
Output drive size	1"	1"	1"	1"	1"	1"
Max. loosening torque	2,300 Nm	3,650 Nm	3,345 Nm	3,345 Nm	3,950 Nm	3,950 Nm
Max. torque in reverse	1,950 Nm	2,700 Nm	2,600 Nm	2,600 Nm	2,900 Nm	2,900 Nm
Working torque range (forward)	174–1,061 Nm	500–2,000 Nm	760–1,800 Nm	760–1,800 Nm	500–2,000 Nm	500–2,000 Nm
Free speed	5,760 rpm	6,000 rpm	3,900 rpm	4,600 rpm	5,900 rpm	5,900 rpm
Impact mechanism	DOUBLE DOG	DUOPACT	Closed Hammer mechanism	Closed Hammer mechanism	DUOPACT	DUOPACT
Air intake thread size	3/8"	1/2"	3/4"	3/4"	1/2"	1/2"
Noise level	96.8 dB(A)	100.8 dB(A)	103.3 dB(A)	103.3 dB(A)	106 dB(A)	106 dB(A)
Length	221 mm	280 mm	428 mm	530 mm	337 mm	490 mm
Weight	3.6 kg	7.2 kg	11.8 kg	12.8 kg	7.2 kg	8.1 kg

Recommended accessories
SOCKET SET
 See page 10



Torque wrench

Model	DMS200	DMS400	DMS1000
Item number	8951000093	8951000094	8951000095
Square size	1/2"	3/4"	1"
Capacity	40–200 Nm	150–750 Nm	200–1,000 Nm
Length	520 mm	1,060 mm	1,255 mm
Weight	2.02 kg	5.84 kg	6.84 kg

€ 129,00 € 599,00 € 699,00

Reliable torque wrenches and, depending on the model, ideal for cars, motorcycles, small and medium-sized trucks, or truck and bus wheel assemblies and machine maintenance.

Torque adjustment with manual locking on the handle, with quick-change system for sockets. Scale in Nm, 4% accuracy in accordance with ISO 6789:2003 requirements.

ALL TORQUE WRENCHES UP TO 25,000 WORK CYCLES



Socket set 3/8"

13-Piece set, model RS3113

Item no.: 8951012354



Short hexagon sockets 3/8", 13-piece set in a plastic case: 7, 8, 9, 10, 11, 12, 13, 14, 15, 16, 17, 18, 19 mm

€ 49,00

Socket set 1/2"

Long design, 3-piece set model RS413WP

Item no.: 8951012362

Wheel protection sockets 1/2", 3-piece in a plastic case: 17, 19, 21 mm



€ 29,00

Socket set 1/2"

3-piece set, model RS413DTW

Item no.: 8951012353



Thin wall sockets 1/2", 3-piece set in a plastic case: 17, 19, 21 mm

€ 119,00

Socket set 1/2"

14-piece set, model RS414

Item no.: 8951012356



Short hexagon sockets 1/2", 14-piece set in a plastic case: 10, 11, 12, 13, 14, 15, 16, 17, 18, 19, 21, 22, 26, 27 mm

€ 55,00

Socket set 1/2"

14-piece set, model RS414D

Item no.: 8951012357



Long hexagon sockets 1/2", 14-piece set in a plastic case: 10, 11, 12, 13, 14, 15, 16, 17, 18, 19, 21, 22, 26, 27 mm

€ 97,00

Socket set 3/4"

8-piece set, model RS618D

Item no.: 8951012359



Long hexagon sockets 3/4", 8-piece set in a plastic case: 26, 27, 29, 30, 32, 35, 36, 38 mm

€ 179,00

Socket set 1"

4-piece set, model RS814D

Item no.: 8951012361



Long hexagon sockets 1", 4-piece set in a plastic case: 27, 32, 33, 36 mm

€ 129,00

Socket set 1"

8-piece set, model RS818

Item no.: 8951012360



Short hexagon socket 1", 8-piece set in a plastic case: 27, 30, 32, 33, 35, 36, 38, 41 mm

€ 179,00

The ratchet product family from RODCRAFT!

Ideal for all applications that require high speeds for fast work and high torque.

- **Planetary gearing with 3 bevel gears**
- **Head closed for higher manually applied torque**
- **Heavy-duty ball-lock drive**
- **Exhaust air adjustable by 360°, 4 power levels adjustable by ring**

Pneumatic ratchet 1/4"

Model RC3068

Item no.: 8951000369

€ 99,00

Output drive size:	1/4"
Housing:	Composite
Max. torque:	45 Nm
Speed:	280 min ⁻¹
Weight:	0.67 kg
Length:	212 mm



Pneumatic ratchet 3/8"

Model RC3268

Item no.: 8951000370

€ 99,00

Output drive size:	3/8"
Housing:	Composite
Max. torque:	50 Nm
Speed:	280 min ⁻¹
Weight:	0.68 kg
Length:	212 mm



Pneumatic ratchet 3/8"

Model RC3278

Item no.: 8951000371

€ 119,00

Output drive size:	3/8"
Housing:	Composite
Max. loosening torque:	100 Nm
Speed:	190 min ⁻¹
Weight:	1.22 kg
Length:	260 mm



Pneumatic ratchet 1/2"

Model RC3678

Item no.: 8951000372

€ 119,00

Output drive size:	1/2"
Housing:	Composite
Max. torque:	100 Nm
Speed:	190 min ⁻¹
Weight:	1.25 kg
Length:	260 mm



Ratchet wrench 1/2"

Model RC3700

Item no.: 8951078074

Output drive size:	1/2"
max. loosening torque:	250 Nm
Speed:	320 min ⁻¹
Weight:	1.6 kg
Length:	312 mm

1/2" ratchet with 130 Nm motor power, which can still be used by hand like a wrench up to 250 Nm.

€ 269,00



Ratchet wrench 1/4"

Model RC3002

Item no.: 8951000503

Output drive size:	1/4"
max. loosening torque:	33 Nm
Speed:	270 min ⁻¹
Weight:	0.45 kg
Length:	132 mm

Very short and powerful 1/4" mini-ratchet for use in confined spaces. Handle with anti-slip coating.

€ 99,00



NEU

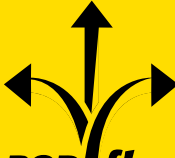

The new **RODflex** series

Flex Head Ratchet 3/8"
Model RC3288

Item no.:8951000460

Free Speed	169 min ⁻¹
Length	272 mm
Max. Torque	80 Nm
Working Torque	53 Nm
Square Drive	3/8"
Weight	1.42 kg

€ 199,00

Flex Head Ratchet 1/2"
Model RC3688

Item no.: 8951000461

Free Speed	165 min ⁻¹
Length	272 mm
Max. Torque	90 Nm
Working Torque	60 Nm
Square Drive	1/2"
Weight	1.43 kg

€ 119,00

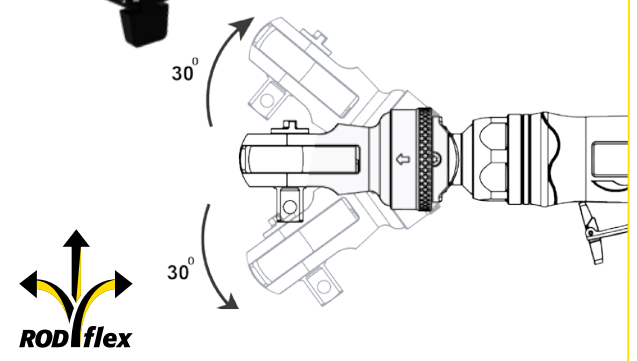

The Flex Head Ratchet is designed to fit in hard-to-reach spaces thanks to its head with 30° rotation up or down. The tool has a safety lever, aluminum alloy housing and TPR grip for a perfect, comfortable and safe usage. This unique design is not only ergonomic, but also fast and powerful with high speed of 165rpm and Max Torque of 90Nm.

Flexible Head Cut-Off Tool
Model RC7199

Item no.:8951000447
RC7199 + Cutting discs
Item no.:8951000457

Spindle Thread	3/8"
Disc	3"
Power	440 w
Free Speed	16000
Weight	1.3 kg
Length	248 mm



€ 187,00

The Flexible Cut Off Tool is designed to fit in hard-to-reach spaces thanks to its head with 25° rotation up or down. The tool has a quick lock ring design for fast flex head position change, a grip & guard made from recycled materials. With outstanding safety with the spark control on the top side of the housing, the RC7199 is an ergonomic, safe and flexible tool.



The MINI SERIES from RODCRAFT

The new product family includes eight tools that cover classic work in confined spaces in vehicle service and industrial maintenance. With a very small design, low weight and high performance, the ergonomic tools have been developed with the usual high Rodcraft quality for professional and long-term use.



MINI-

**Die grinder
Model RC7001**

Item no.: 8951000428



For straight access to the workpiece

- Only 116 mm long
- Up to 25,000 rpm
- With 6 mm collet

€ 69,00

MINI-

**Die grinder
Model RC7102**

Item no.: 8951000429



Grinding head 90° angled for hard-to-reach places

- Only 126 mm long
- Up to 18,000 rpm
- With 6 mm collet

€ 112,00

MINI-

**Angle grinder
Model RC7103**

Item no.: 8951000430



Compact design for cutting and grinding in confined spaces

- Only 129 mm long
- Up to 18,000 rpm
- For 50 to 59 mm cutting discs (2"-2.5")

€ 122,00

MINI-

**Disc sander
Model RC7601**

Item no.: 8951000431



Compact design for grinding in confined spaces

- Only 126 mm long
- Up to 18,000 rpm
- For 50 mm quick-change abrasive pads (Roloc/swivel mount)

€ 112,00

**LIGHTWEIGHT,
ERGONOMIC
AND POWERFUL**

**... for working
in confined spaces**

MINI-

**Polisher
Model RC7602**

Item no.: 8951000432



Compact design for use in confined spaces

- Only 152 mm long
- Perfect polishing speed with up to 4,500 rpm
- For 50 mm quick-change polishing pads (Velcro/Klett)

€ 142,00



MINI-

**3/8"
Ratchet wrench
Model RC3201**

Item no.: 8951000433

For use in confined spaces

- Only 135 mm long
- 3/8" output drive size
- Fast screwing with up to 300 rpm
- 50 Nm torque

€ 99,00

MINI-

**Multifunction
ratchet wrench
Model RC3202**

Item no.: 8951000434

With interchangeable square and hexagonal inserts

- Only 160 mm long
- Incl. 5 interchangeable inserts (3/8", 1/4" Bit holder, hexagon socket: 10 mm, 12 mm, 13 mm and 17 mm)
- Rubber-coated ratchet head to protect sensitive parts
- Fast screwing with up to 400 rpm
- 50 Nm torque



€ 169,00

Drill in a pistol design model RC4108

Item no.: 8951000422



- With high-quality quick-change chuck from Jacobs®
- Cold-insulating and lightweight composite housing
- Sensitive trigger for more control when drilling
- Right / left switch directly next to the release button
- Good weight balance and low weight (1.1 kg)

€ 139,00

Drill in a pistol design Model RC4560

Item no.: 8951000423



- With high-quality quick-change chuck from Jacobs®
- The additional handle is lightweight and individually adjustable by 360 degrees (model with 13 mm and 800 rpm)
- Sensitive trigger for more control when drilling
- Right / left switch directly next to the release button
- Good weight balance and low weight (1.3 kg)

€ 183,00

Angle drill Model RC4660

Item no.: 8951000424



- With high-quality quick-change chuck from Jacobs®
- Compact, low profile for easy access in cramped locations
- Safety trigger for controlled work without accidental start-up
- Integrated ring for changing from right to left rotation
- Good weight balance and low weight of only 1.1 kg
- Cold-insulating and lightweight composite housing

€ 183,00

Straight drill Model RC4610

Item no.: 8951000425



- With high-quality quick-change chuck from Jacobs®
- Compact, low profile for easy access in cramped locations
- Safety trigger for controlled work without accidental start-up
- Good weight balance and low weight of only 1 kg
- Cold-insulating and lightweight composite housing

€ 143,00

With the four pneumatic drills and the two pneumatic screwdrivers from RODCRAFT workshops for vehicle servicing or companies in the field of industrial repair and assembly are fully equipped - flexible, ergonomic and with a long service life.

CHUCK



€ 19,00

Item no.: 8951011458

Self-tightening 10 mm compound chuck with non-slip coating, "RÖHM®" quality.

Item no.: 8951011459

Self-tightening 13 mm composite chuck with non-slip coating, "RÖHM®" quality.



€ 15,00

Item no.: 8951011451

10 mm key chuck with non-slip coating, "RÖHM®" quality.

Item no.: 8951011452

13 mm key chuck with non-slip coating, "RÖHM®" quality.



€ 2,00

Item no.: 8951011453

Key for chucks

Screwdriver in a pistol design

Model RC4710

Item no.: 8951000426



- Quick-change chuck, 1/4" hexagon socket for quick tool changes
- Fast and exact torque adjustment, 2 – 6 Nm, sensitive trigger and progressive valve for controlled screwing
- Cold-insulating and lightweight composite housing
- Slim housing for perfect handling, low weight of only 1.1 kg

€ 149,00

Rod screwdriver

Model RC4770

Item no.: 8951000427



- Quick-change chuck, 1/4" hexagon socket for quick tool changes, speedy and precise torque adjustment, 2 – 6 Nm
- Integrated ring for right/left rotation, safety trigger for controlled work without accidental start-up
- Cold-insulating and lightweight composite housing (only 1.1 kg), optional balancer bracket

€ 149,00

Model	RC4108	RC4560	RC4660	RC4610	RC4710	RC4770
Item number	8951000422	8951000423	8951000424	8951000425	8951000426	8951000427
Power	400 W	400 W	300 W	500 W	400 W	300 W
Speed	2,000 rpm.	800 rpm.	1400 rpm.	3,000 rpm	2000 rpm.	2,000 rpm.
Torque	6.5 Nm.	13.5 Nm.	6.5 Nm.	5.5 Nm.	2–6 Nm.	2–6 Nm.
Free speed Air consumption	1.88 l/s	1.88 l/s	1.54 l/s	1.78 l/s	1.84 l/s	1.63 l/s
Shape	Pistol	Pistol	Angled	Straight	Pistol	Straight
Reversible	Yes	Yes	Yes	No	Yes	Yes
Weight	1.05 kg	1.33 kg	1.06 kg	1.03 kg	1.05 kg	1.06 kg
Chuck capacity / Output drive	10 mm	13 mm	10 mm	10 mm	1/4" bit drive	1/4" bit drive
Noise level	90 dB(A)	89 dB(A)	85.2 dB(A)	84 dB(A)	90.3 dB(A)	85.0 dB(A)
Vibration	2.1 m/s ²	1.5 m/s ²	2.73 m/s ²	2.87 m/s ²	1.2 m/s ²	0.61 m/s ²
Dimensions L x W x H [mm]	195 x 40 x 155	230 x 43 x 155	207 x 43 x 120	245 x 72 x 50	212 x 42 x 155	258 x 56 x 42



Chisel hammer Model RC5100

Item no.: 8951071022

**Pneumatic hammer with
11 mm hexagonal shaft
Bare tool, chisel not included**



Power: 6 joules
Bore: 19 mm
Height: 160 mm
Width: 39 mm
Length: 200 mm
Stroke: 60 mm
Shaft: 11 mm

€ 75,00

Chisel hammer set Model RC5120

Item no.: 8951171013



**Complete set for metalworking and
processing metal sheets.
In a toolbox with:**

**pneumatic hammer RC5100 /
holding spring RC70
Rivet removal chisel RC22S
Spot-weld separation chisel RC19S
Double-edged sheet metal chisel RC60S
Flat chisel RC20S
Curve separation chisel RC18S**

€ 99,00

Chisel hammer set Model RC5150

Item no.: 8951171023



**Complete set for processing
concrete and stone.
In a toolbox with:**

**pneumatic hammer RC5100 /
Solid bracket RC76-1
Sharp chisel 240 mm long SS10
Flat chisel 240 x 20 mm SS20
Flat chisel 240 x 30 mm SS30
Flat chisel 240 x 40 mm SS40
Hollow joint chisel 240 mm SS50**

€ 159,00

Chisel hammer Model RC5176

Item no.: 8951171043

- Ready-to-use hammer set for concrete and stone processing
- Hexagonal shaft allows directional chisel guidance
- Included in set:
 - 8951071042 - Hammer RC5175
 - 8951011958 - Chisel spring retainer D34
 - 8951011932 - Chisel 11mm hex shank-210mm Pointed SS10
 - 8951011934 - Chisel 11mm hex shank-210mm SS20
 - 8951011962 - Retainer chisel steel RC76-1



€ 199,00

Chisel hammer Model RC5185/vibration damped

Item no.: 8951000152

- Highly efficient: 9 joules / 3,000 impacts/min
- Low vibrations: Pistons on air cushions
- High durability and lightweight
- Simple to operate Quick-change chuck
- Curved, ergonomic handle with cold-insulating rubber area for a perfect grip



€ 195,00

Chisel hammer Model RC5195/vibration damped

Item no.: 8951000154

- Highly efficient: 12 joules / 2,100 impacts/min
- Low vibrations: Pistons on air cushions
- High durability and lightweight
- Simple to operate Quick-change chuck
- Curved ergonomic handle with TPR inserts on the back for more comfort and for decoupling



€ 214,00

Chisel hammer 12 mm, model RC5305

Item no.: 8951071065

Power: 6 joules
Bore: 20 mm
Stroke: 50 mm
Shaft: 12 mm



€ 420,00

Powerful for heavy-duty applications. Small, straight hammer for metal or stone with 12 mm hexagonal holder, chisel holder made of steel RC76-3

Chisel hammer SET 12 mm, model RC5310

Item no.: 8951171053

Contains RC5305 and 4 chisels:



- Sharp chisel 210 mm long RC51S
- Flat chisel 210x20 mm RC52S
- Flat chisel 210x30 mm RC53S
- Flat chisel 210x40 mm RC54S

For working on concrete and stone in a toolbox with pneumatic RC5305, solid holder RC76-3.

€ 471,00

Chisel hammer 14.7 mm, model RC5400

Item no.: 8951071076

Power: 22 joules
Bore: 29 mm
Stroke: 76 mm
Shaft: 14.7 mm



Chisel hammer for the most demanding work. Powerful, large hammer with 14.7 mm hexagonal shaft for heavy-duty applications. Chisel hammer made from steel

€ 499,00

Universal chisel Model RC92

Item no.: 8951011953



Mount: 14.7 mm hexagonal
Length: 190 mm
Width: 30 mm
€ 25,00

Sharp chisel Model RC93

Item no.: 8951011954



Mount: 14.7 mm hexagonal
Length: 185 mm
€ 24,00

Flat chisel

Model	SS20	SS30	SS40
Width	20 mm	30 mm	40 mm
Item number	8951011934	8951011936	8951011938
Length	210 mm	205 mm	210 mm
Mount	11 mm hexagonal	11 mm hexagonal	11 mm hexagonal
	€ 15,00	€ 16,00	€ 16,00

Needle scaler

Model RC5610

Item no.: 8951076001

- 2 in 1 tool – Needle scaler / weld flux chipping hammer
- For scaling and paint removal with one tool.
- Scraper for removing larger sheets of paint, rust or weld flux.
- For thick sheet metal or stone / concrete (not suitable for thin sheet metal).



€ 299,00

Needle scaler

Model RC5615

Item no.: 8951076002

- Small device for confined spaces.
- For removing rust and other deposits from rims or frame parts.
- For thick sheet metal or stone / concrete (not suitable for thin sheet metal).



€ 135,00

Needle scaler

Model RC5620

Item no.: 8951076003

- Heavy pistol-shaped tool
- With 4 mm needles for coarse rust removal
- With 28 x 3 mm needles for moderately heavy work on large areas
- Only for use on thick sheet metal or stone / concrete (not suitable for thin sheet metal)



€ 445,00

Needle scaler

Model RC5625

Item no.: 8951076004

- Lightweight pistol-shaped tool
- With 3 mm needles for moderately severe rust removal
- With 29 x 2 mm needles for carving out fine details or working on larger surfaces
- Only for use on thick sheet metal or stone / concrete (not suitable for thin sheet metal)



€ 254,00

Needle set for RC5625



19 X 3 mm

29 X 2 mm

Item no.: 8940159860 Item no.: 8951011504

€ 28,00

€ 30,00



The RC7155/7156 belt sander range is perfect for body shop and general repair jobs

- Quick replacement of the sanding belts (10 mm and 20 mm) thanks to the quick-release device
- Efficient working with a speed of 18,000 rpm
- Adjustable sanding arm for better reachability
- Small and manageable tool for confined spaces
- Exhaust air routing to the rear for greater occupational safety

**Belt sander
Model RC7155**

Item no.: 8951072041

Power: 300 W
Speed: 18,000 rpm
Length: 285 mm
Weight: 0.8 kg
Sanding belt (L x W): 330 x 10 mm



€ 175,00

**Belt sander
Model RC7156**

Item no.: 8951072051

Power: 370 W
Speed: 17,000 rpm
Length: 353 mm
Weight: 1.15 kg
Sanding belt (L x W): 520 x 20 mm



€ 299,00

Sanding belts

Grain size	Item no.	Dimensions	Quantity	Grain size	Item no.	Dimensions	Quantity
€ 18,00	40	10 x 330 mm	10	€ 25,00	80	20 x 520 mm	10
€ 16,50	80			€ 23,00	120		
€ 16,50	120			€ 23,00	180		
€ 16,50	180			€ 22,00	240		
€ 16,50	240						



**Pistol sander
Model RC7150**

Item no.: 8951072021

The RC7150 disc sander is the perfect tool for automotive and body shops to efficiently sand and smooth surfaces



- High-speed disc sander with 18,000 rpm
- Integrated air regulator with throttle valve for a finely adjustable speed
- Robust, energy-efficient 500 watt motor

€ 85,00

**Mini pistol sander
Model RC7681K**

Item no.: 8951000019

The RC7681K mini disc sander is ideal for body shop applications



- Efficient working with a maximum speed of up to 15,000 rpm
- Lightweight composite body weighing only 0.4 kg and rubberized grip for ergonomic handling
- Adjustable power control with thumb button for one-handed operation

€ 149,00



HIGHLIGHT-PRODUCT

Orbital sander

One-hand/two-hand orbital sander

Model	Item number	Orbit	Speed	Padø	Weight	Air consumption	Air intake thread size
€ 245,00 RC7702V6	8951000021	2.5 mm	10,000 rpm	150 mm	0.83 kg	7.5 l/s	1/4" BSP
€ 254,00 RC7705V6	8951000020	5 mm	10,000 rpm	150 mm	0.85 kg	7.5 l/s	1/4" BSP
€ 289,00 RC7710V6	8951000070	10 mm	10,000 rpm	150 mm	0.95 kg	7.5 l/s	1/4" BSP
€ 335,00 RC7710V6-2H	8951000082	10 mm	10,000 rpm	150 mm	1.1 kg	7.5 l/s	1/4" BSP

Particularly powerful motor with 285 watts for vertical and horizontal applications

Manageable and lightweight tool with high operating comfort thanks to the ergonomic palm shape with soft grip for perfect control



Available as a one-handed version model RC7705V6 and two-handed version with additional handle RC7705V6-2H

The lightweight and powerful RC7705V6/RC7705V6-2H series orbital sanders are perfect for final sanding, finishing and pre-polishing



Replacement sanding disc
Item no.: 8955000012



€ 29,00

For models RC7710V6 and RC7705V6-2H.

Orbital sander Model RC7661V

Item no.: 8951072231

The RC7661V is an orbital sander for use in body and paint shops



Orbital sander with 2.5 mm orbit for final sanding, finishing and pre-polishing. Pad diameter 75 mm.

€ 195,00

Orbital sander / pad diameter 50 mm / 75 mm Model RC7682

Item no.: 8951000005

The RC7682/7682K range of mini pistol-shaped orbital sanders are the ideal tools for surface preparation and spot repair



- Efficient working with a 5 mm orbit and a speed of 15,000 rpm
- Lightweight composite housing only 124 mm in length and weighing only 0.5 kg and with a rubberized grip for ergonomic handling

€ 129,00

Orbital sander 200 mm Model RC7691V

Item no.: 8951072212

The RC7691V orbital sander is the ideal tool in body shops and paint shops



Particularly powerful motor with 210 watts for aggressive and efficient sanding on large areas

€ 359,00

Pneumatic orbital sander as a set, model RC7682K

Item no.: 8951000018

Small powerful sander for quick completion of small areas of sanding / smart repair

- Speed regulation in the grip area
- Incl. supporting disc ø50+75 mm
- Incl. 10 sanding discs each with a grain size of 600, 320, 180, in ø50+70 mm

€ 179,00

Lift: 5 mm
Orbit: 5 mm
Speed: 15,000 rpm
Weight: 0.53 kg
Noise level: 79.6 dB(A)
Vibration: 8.9 m/s²
Air connection: 1/4"



Die grinder

The RC7028/RC7048/RC7128 ranges of sanders are perfect for automotive, body shops and general maintenance shops



Model	RC7028	RC7048	RC7128
Item number	8951000275	8951000276	8951000277
Power	400 W	400 W	400 W
Speed	27,000 rpm	27,000 rpm	23,000 rpm
Length	191 mm	250 mm	169 mm

€ 115,00

€ 135,00

€ 145,00

Mini die grinder

Model RC7051

Item no.: 8951000165



- High speed of 60,000 rpm for efficient working
- Collet for 3 mm sanders and milling cutters
- Sound absorbing hose included for a low noise level of 71 dBA

€ 139,00

Die grinder Model RC7009

Item no.: 8951000274

The RC7009 rod sander is perfect for general maintenance jobs and for high-speed sanding



€ 59,00

Very robust and powerful 300 watt motor with 30,000 rpm for continuous use.

Die grinder Model RC7058

Item no.: 8951000278

The RC7058 is the powerful and ergonomic sander for general maintenance and everyday use



€ 139,00

Efficient work with an power of 700 watts and up to 23,500 rpm.

Engraving pen Model RC5030

Item no.: 8951071010



The Rodcraft RC5030 pneumatic engraver is the ideal tool for any workshop to permanently mark or number parts

€ 179,00

Pneumatic die grinder 400 W, 2,800 rpm Model RC7068

Item no.: 8951000329



€ 139,00

The RC7068 is the high-torque and ergonomic die grinder for maintenance and everyday use

Efficient work with an power of 400 watts and up to 2,800 rpm.

WWW.RODCRAFT.COM

You will also find our complete range online:

- Online catalog pneumatic tools
- Online catalog repair shop equipment
- Rodcraft accessories
- Technical documentation
- Rodcraft sales and dealer contacts

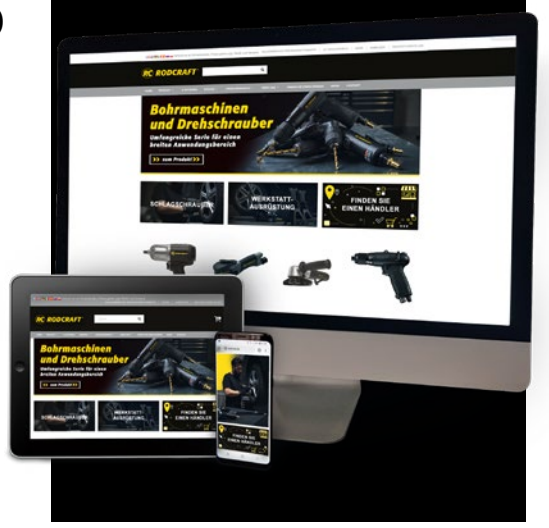

Tire buffer

Model RC7088

Item no.: 8951000330

Popular carcass sander with high torque and keyless chuck.

- Powerful, low-revving planetary gearing.
- With quick-change mounts with thread adapter 3/8"-24.
- Free speed: 2,800 rpm
- Power: 400 watts
- Air inlet: 1/4"
- Weight: 1 kg



€ 139,00

Disc 3/8" for tire buffer

Item no.: 8940175873



€ 24,00

Die grinder

Model RC7038

Item no.: 8951000328

- Mount: 5/16"
- Speed: 2,800 rpm
- Power: 400 watts
- Weight: 1.0 kg

€ 135,00



Erasing disc

Item no.: 8951011677

€ 11,00



Optimal for removing foils and stickers as well as adhesive residues from balancing weights on rims



Polisher Model RC7683

Item no.: 8951000004

The RC7683 range of mini polishers is perfect for body shop, body repair and paint shop jobs.



€ 129,00

Polisher in a set, model RC7683K

Item no.: 8951000017



€ 177,00

Small powerful polisher ideal for smart repairs

- Speed regulation in the grip area
- Incl. supporting disc ø 75 mm
- Incl. 1 white and 1 yellow polishing foam and and 1 polishing pad

Sandblasting machine Modell RC8112

Art.-Nr.: 8951070003

Portable blast media container (10 L) with a long (5 m) blast media suction hose for connection to the container and gun.

Geeignet für

- structural steel
- wheel rim repair
- automotive bodywork
- repairs to passenger cars, commercial vehicles, and trucks
- mechanical engineering and industrial applications



€ 69,00

Angle grinder Model RC7190

Item no.: 8951075101

The small RC7190 direct-drive cutting sander with its straight design is ideal for cutting in confined spaces

- Adjustable speed up to 20,000 rpm
- For discs up to 75 mm
- High level of safety thanks to an easily adjustable protective hood made of steel and a safety release



€ 75,00

Cutting discs for model RC7190

Item no.: CA155312



Set of 5 discs
Dimensions: 75 x 2 x 10 mm

€ 9,90

Angle grinder, incl. 5 cutting discs Model RC7170

Item no.: 8951000144



- Ideal for cutting composite materials, metal, screws.
- 100 mm-long shaft
- compact housing
- incl. 5 Norton® cutting discs

€ 285,00

Angle grinder Model RC7166

Item no.: 8951075051

€ 182,00



- Powerful with 750 watts and 10,000 rpm
- For 115 mm and 125 mm cutting and sanding discs. With M14 spindle thread and therefore compatible with power tool accessories.

Angle grinder (125 mm) Model RC7173

Item no.: 8951000212

High power with 700 watts and a speed of 12,000 rpm thanks to the regulated motor that maintains the optimum speed at high working torque.

€ 299,00

- maintenance interval 1,000 hours
- High-quality spiral bevel gears and high-performance motor

RC7095/ RC7095K MBX Multi Sander

Work efficiently on all kinds of surface preparation

The Rodcraft RC7095 MBX Multi Sander has been developed to better serve customers working in general mechanics maintenance or body shop applications.

This Multi Sander tool is a complete solution for all kinds of surface preparation such as rust removal, corrosion, paint, plastic film, labels, underseal, sealing compound and paint stripping on any type of supports.

- Detachable dust extraction system
- 180° Easily adjustable side handle
- 1.4 Kg with accessories
- Arc Guard for operator's safety
- Speed regulator at top of housing
- Composite housing
- Recyclable materials on guard and vacuum



Technical data

Model	RC7095	RC7095K
Item number	8951000450	8951000462
Power	346 W	346 W
Speed	3,893 rpm.	3,893 rpm.
Length	332 mm	332 mm
Width	84 mm	84 mm
Height	260 mm	260 mm
Net weight	1.4 kg	1.4 kg
Sound pressure dB(A)	83.2 dB(A)	83.2 dB(A)
Vibration	2.2 m/s ²	2.2 m/s ²
Air inlet thread size (")	1/4"	1/4"
Free speed air consumption	1.5 l/s	1.5 l/s
EAN	4030178835292	4030178835339

€ 439,00 € 599,00



RC7095K
Kit including accessories

Accessories



HUB system

Item no.: 8955000129
HUB width 23 mm

€ 25,00



HUB system

Item no.: 8955000130
HUB width 11 mm

€ 24,00



Wire wheel (fine)

Item no.: 8955000134
wheel width 11 mm

€ 32,00



Wire wheel (medium)

Item no.: 8955000133
wheel width 11 mm

€ 32,00

Item no.: 8958001557
wheel width 23 mm

Item no.: 8958001558
wheel width 23 mm



Wire wheel (coarse)

Item no.: 8955000131
wheel width 23 mm

€ 26,00

Item no.: 8955000132
wheel width 11 mm



4" Rubber eraser wheel

Item no.: 8955000135
wheel width 30 mm

€ 28,00



4" Stripping wheel

Item no.: 8958001556

€ 28,00



RCA1000, Motor oil 1L

Item no.: 8955000117

€ 28,00



Saw Model RC6050

Item no.: 8951079001



- With blade change from the outside and exhaust air to the rear
- Handy and fast, with an insulated handle
- Lift: 10 mm
- Speed: 500 rpm

€ 134,00

Saw Model RC6067

Item no.: 8951079011



- Powerful pneumatic air saw with composite handle, suitable for cutting spars and multi-layer sheet metal parts
- With long saw blades, profiles and silencer pipes can be processed in one cut
- 10,000 strokes/min
- Can be converted to a pneumatic air file using an adapter (optional accessory)
- Handy and fast, with an insulated handle

€ 259,00

Sheet metal nibbler Model RC6100

Item no.: 8951076008



- Ideal for cutting car body and aluminum sheets
- Cutting speed: 2.6 m/min
- Max. sheet thickness: 1 mm
- Cutting width: 4 mm
- Weight: 0.95 kg
- Noise level: 91.6 dB(A)
- Vibration: 8.55 m/s²
- Air connection 1/4"

€ 123,00

Saw blades

- Set of 5 blades
- Length: 93 mm
- Suitable for models RC6050 and RC6067



Saw Model RC6051

Item no.: 8951179000



- Cold-insulated handle
- 10 mm saw blade stroke
- Perfect for dimensionally accurate sawing of body parts, spars and profiles

€ 199,00

Saw Model RC6070

Item no.: 8951000463



- A gear driven saw that is reshaping the landscape of maintenance
- Keyless blade changing mechanism and protective guards for perfect grip
- Max speed of 4,600 strokes/min., minimum speed of 4,200 strokes/min.
- Alternating speeds to choose between ultimate efficiency or prolonged blade life

€ 366,00

Punch machine Model RC6301

Item no.: 8951076011



The RC6301 punch and stripping pliers is the ideal combination tool for welding preparation in bodywork and sheet metal processing

- For cutting and punching up to a maximum material thickness of 1.2 mm
- Punches 5 mm holes for weld preparation, also suitable for spot weld preparation

€ 136,00

Spot welding drill Model RC6453

Item no.: 8951076013

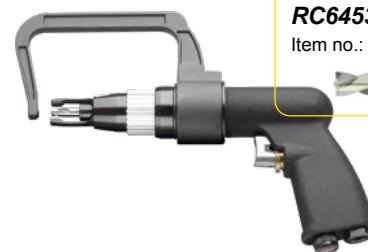

Drill bit for
RC6453
Item no.: 8951011524

€ 11,50

Spot weld cutter for professionals in auto body and sheet metal work, designed for the precise and convenient removal of spot welds

- The cutter is automatically pressed against the sheet metal when the tool is started, ensuring precise removal of the spot weld
- Cutting depth adjustable to within 50 microns

€ 459,00

Pneumatic rivets guns and rivet nut setting tool



Riveter
Model RC6700
Item no.: 8951074001

Rivet gun for blind rivets made from soft metals such as copper, aluminum 2.4–5.0 mm with collection container for pulled off rivet mandrels.

Setting force: 8.8 kN

€ 145,00



Riveter
Model RC6738
Item no.: 8951000408

Rivet gun for blind rivets made from high-strength materials such as steel and stainless steel 3.0 - 5.0 mm with collection container for pulled off rivet mandrels and suction of blind rivets, ideal for comfortable vertical work.

Setting force: 12.6 kN

€ 269,00



Riveter
Model RC6748
Item no.: 8951000409

Rivet gun for blind rivets made from high-strength materials such as steel and stainless steel 4.8 - 6.4 mm, as well as special rivets (e.g.: BULB-TITE®) up to 7.8 mm. With collection container for pulled off rivet mandrels and suction of blind rivets, ideal for comfortable vertical work.

Setting force: 21.0 kN

€ 615,00



Blind rivet nut setting tool
Model RC6758
Item no.: 8951000410

Blind rivet nut setting tool for rivet nuts M3–M12 made from all materials. Fast handling of the rivet nut using automatic twisting and unscrewing. Precise adjustment of the setting stroke.

Setting force: 24.0 kN

€ 1259,00

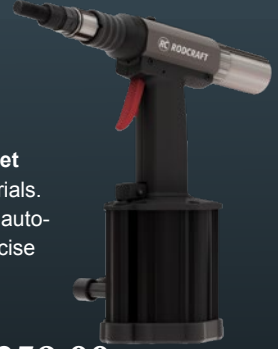

Model		RC6700	RC6738	RC6748	RC6758
Standard blind rivets with open / closed end	Aluminum	2.4–5.0 mm	3.0–5.0 mm	4.8–6.4 mm	–
	Copper	2.4–5.0 mm	3.0–5.0 mm	4.8–6.4 mm	–
	Steel	–	3.0–5.0 mm	4.8–6.4 mm	–
	Stainless steel	–	3.0–5.0 mm	4.8–6.4 mm	–
Structure blind rivets	BULB-TITE®	–	–	5.2–7.8 mm	–
	Monobolt®, Magnalok®, Interlok®	–	–	4.8–6.4 mm	–
	Hemlok®	–	–	6.4 mm	–
Blind rivet nuts	Single-grip	–	–	4.8–5.0 mm	–
	all materials	–	–	–	M3–M12
Additional tool function	Suction of rivet mandrels	yes	yes	yes	–
	Vacuum function for the suction of blind rivets	–	yes	yes	–

**"UNICUTTER" –
Windscreen removal tool
Model RC6605RE**

Item no.: 8951074005



Universal cutting, scraping and sawing device for removing car windscreens.

€ 152,00

Glass removal blade

Blades U-shape



Model	U27	U37	U64	U95
Item number	8956001320	8956001328	8956001324	8956001325
Blade length	24 mm	36 mm	63 mm	90 mm
PI	2 blades	2 blades	2 blades	2 blades

€ 62,00 € 49,00 € 58,00 € 62,00

**Glass removal blade GR
SET**

Item no.: 8956001327
Set comprises
U-shaped and
straight blades.
(7 blades)



€ 166,00

**Oscillation cutter /glass
removal tool
Model RC6606RE**

Item no.: 8951174000

Perfect for any car and body shop that needs to quickly and professionally replace vehicle windows



€ 244,00

**Windscreen removal tool
Model RC6610**

Item no.: 8951074000



Exhaust air at the rear end of the tool for high occupational safety

€ 309,00

Blades straight



Model	G36	G58	G95
Item number	8956001323	8956001322	8956001321
Blade length	35 mm	53.5	90 mm
PI	2 blades	2 blades	2 blades

€ 26,00 € 26,00 € 62,00

**Double suction cup set
Model STS71K**

Item no.: 8951011087



Two double suction cups for transporting, installing and removing windscreens and other glass panes. Comes with a strap that holds the windshield in place while the adhesive dries.

(max. 80 kg)

€ 71,00

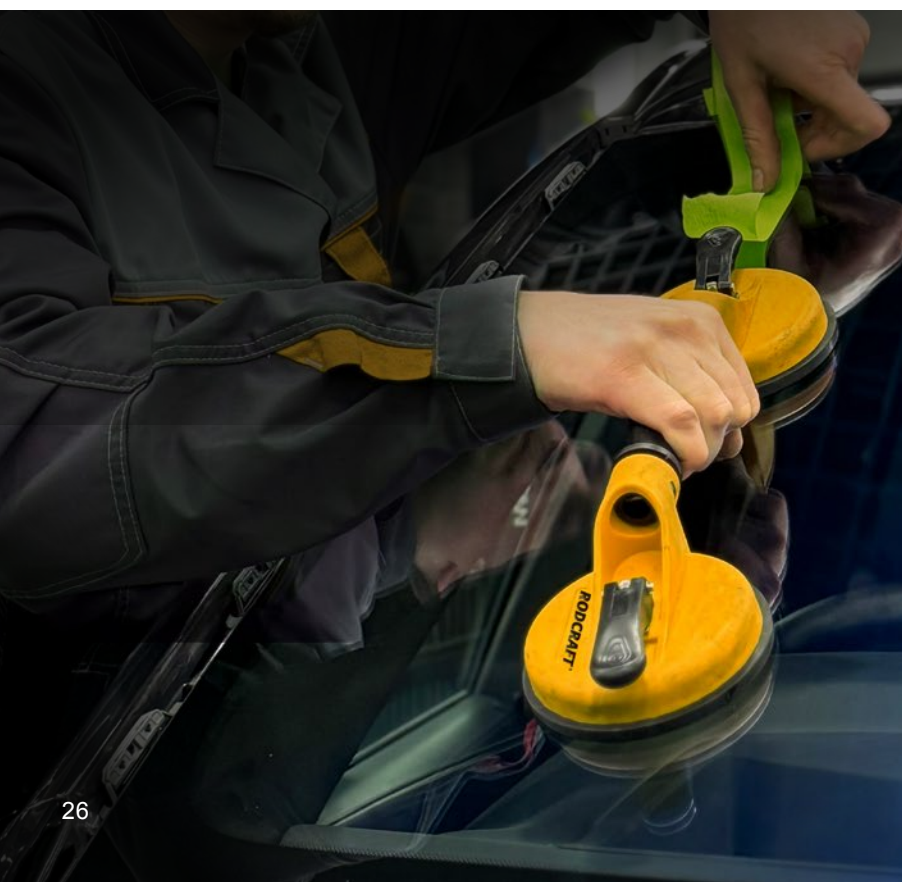

Blow and suction gun

Model RC8116

Item no.: 8951070004



Robust metal housing with 4 different nozzles, suction hose and dust bag made of fabric. Ideal for residue-free suctioning when repairing tires.

Air pressure: 6 bar
Air connection: 1/4"

€ 55,00

Air blow gun

RC8240S

Item no.: 8955000009



€ 22,00

RC8241S

Item no.: 8955000011



€ 25,00

RC8241

Item no.: 8955000010



€ 20,00

RC8240

Item no.: 8955000026



€ 19,00

The safety nozzles prevent paint scratches and are significantly quieter than standard nozzles. Large airflow even at low pressure - twice as powerful as a standard air gun. Gentle start-up thanks to an easily adjustable valve. Stable air inlet with brass internal thread.

Cleaning gun

Model RC8011

Item no.: 8951070040



The RC8011 pneumatic cleaning gun is perfect for workshops that deal with underbody protection.

€ 29,00

Cleaning gun

Model RC8035

Item no.: 8951070050

Spray gun for multiple applications:

Underseal spray gun for 1 l cans with screw thread

Cavity sealing gun with nozzle tube for 1 l cans

Cleaning spray gun with 1 l tank and nozzle tube with adjustable spray nozzle

Disinfectant gun for air conditioning and air ducts with tanks



€ 69,00

Paint gun

Model RC8102-14

Item no.: 8951070002



0.6 l plastic paint cup, equipped with 1.4 mm nozzle

- Beam shape adjustable (round or narrow, rotatable nozzle head)
- Finely adjustable operating lever
- Air volume adjustment
- Quantity limitation

€ 145,00

Cartridge gun

Model RC8000

Item no.: 8951070000



€ 49,00

With steel cylinder for cartridges up to 310 ml and a size up to 220x50mm.

Grease gun, filled

Model RC8150F

Item no.: 8951012205



€ 17,00

Particularly suitable for lubricating angle gears and impact mechanisms.

Grease gun filled with 2 cartridges

model RC8150

Item no.: 8951012204



Lubrication gun/grease gun RC8150, incl. 2 cartridges (filled), 168 x 34 mm

€ 39,00

5 replacement cartridges

model RC8150K

Item no.: 8951012206

Refill cartridges (5 cartridges for RC8150)



€ 24,00

Grease gun

Model RC8132

Item no.: 8951000059



The RC8132/RC8141 range of grease guns should be part of every workshop for general maintenance and lubrication work

€ 49,00

Grease gun

Model RC8141

Item no.: 8951070090



- For cartridges 215 x 50 mm (400 ml), bags or direct filling via a lubricant tank
- Progressive trigger for even distribution of lubricant (continuous or point by point)

€ 129,00

Tyre filler calibrated with torque plug nipple, model RF02G

Item no.: 8951011019



Professional tire inflator with 500 mm hose and torque plug nipple. Calibrated pressure display 0 - 10 bar. Lightweight design with analog 60 mm pressure gage and shock protection.

Push button to lower tire pressure and lever to inflate

€ 59,00

Rodcraft workshop equipment for professional repair and assembly work

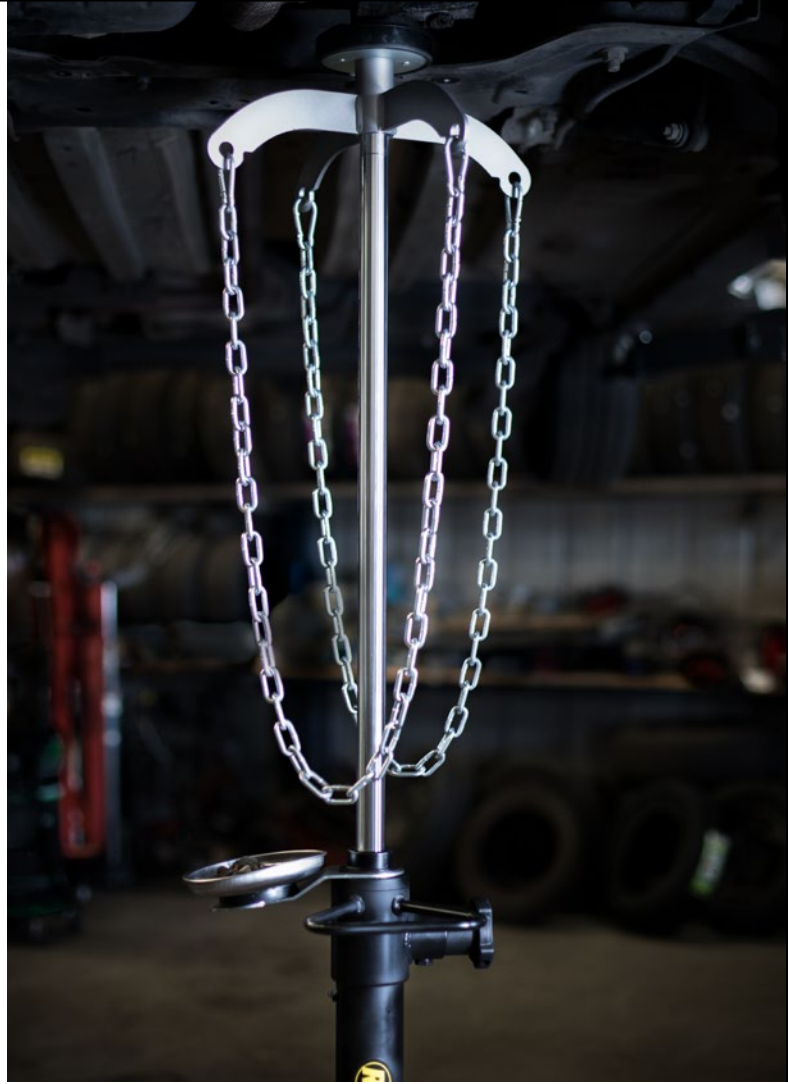

Creeper foldable, model RSF01

Item no.: 8951089021

2-in-1: Assembly roller board and sliding seat for various working heights. Comfortably padded, easy to clean surfaces.



- Load-bearing capacity 90 kg
- Height: 480 mm
- Width: 450 mm

€ 99,00

Creeper Model RSF02

Item no.: 8951089020

Low roller board: 115mm



- Only weights 4.8kg
- Cut-out arm area for more freedom of movement

€ 59,00



Jack Stands

The UBZ range of safety stands is a must for every workshop when working on raised vehicles



Model	UBZ-2	UBZ-3	UBZ-6
Item number	8951000027	8951000028	8951000029
Load capacity	2 t	3 t	6 t
Min. height	280 mm	300 mm	400 mm
Max. height	425 mm	455 mm	620 mm
Stroke	145 mm	155 mm	220 mm
Weight	2.5 kg	3 kg	5 kg

€ 49,00 € 61,00 € 95,00

Bottle jack

The hydraulic jacks of the Rodcraft MGN range can be used universally in the workshop and in the breakdown service

- Compact hydraulic jack with hand pump
- Stable welded construction and high stability due to the large base plate
- Maximum durability and resilience through double piston guide
- Safety valve to protect against overload.
- Can be used vertically or horizontally



Model	MGN2	MGN5	MGN12	MGN20	MGN30
Item number	8951000009	8951000011	8951000013	8951000014	8951000015
Load capacity	2 t	5 t	12 t	20 t	30 t
Min. height	178 mm	198 mm	176 mm	182 mm	280 mm
Max. height	347 mm	390 mm	347 mm	308 mm	445 mm
Stroke	169 mm	192 mm	171 mm	126 mm	165 mm
Weight	2.4 kg	3.8 kg	7.33 kg	9.1 kg	18.3 kg

€ 55,00 € 75,00 € 119,00 € 154,00 € 227,00

Trolley jacks



Up to 2.5 tons load capacity



Model	RH136	RH152	RH201	RH251	RH216
Item number	8951000411	8951000459	8951000003	8951082024	8951000388
Load capacity	up to 1.5 t	1,5 t	2 t	2 t	2.5 t
Weight	14.3 kg	42.5 kg	20.5 kg	58 kg	32 kg
Min./max height	90 / 358 mm	78 / 540 mm	85 / 460 mm	135 / 800 mm	75 / 500 mm
Chassis length	485 mm	920 mm	695 mm	1,340 mm	685 mm
	€ 199,00	€ 456,00	€ 469,00	€ 530,00	€ 284,00

3 to 5 tons load capacity



Model	RH290	RH316	RH501
Item number	8951082031	8951000458	8951082050
Load capacity	3 t	3 t	5 t
Weight	41.5 kg	41 kg	95 kg
Min./max. height	145 / 490 mm	95 / 520 mm	150 / 680 mm
Chassis length	650 mm	734 mm	1420 mm
	€ 265,00	€ 335,00	€ 899,00

Air-hydraulic jacks

Air-hydraulic jack up to 20 t

Low compressed air requirement (300 l/min) for connection to truck braking system (only 7-10 bar required)

Model LHH22

Item no.: 8951084201

Load capacity: 20 t

Weight: 49 kg
Min./max. height: 210/435 mm
Chassis length: 430 mm

€ 655,00



Air-hydraulic jack up to 30 t

Low profile and large lift. Faster and easier lifting – controlled via the valve on the hose: integrated pneumatically driven hydraulic pump without pumping by hand

Model LHH35

Item no.: 8951084350

Load capacity: 30 t

Weight: 54.4 kg
Min./max. height: 255/488 mm
Chassis length: 610 mm

€ 799,00



Hydraulic jack up to 30 t

Ideal for trucks and buses thanks to the high lifting capacity. Quick and easy control via the handle. Low profile, easy to maneuver.

Model ATJ30-2

Item no.: 8951000269

Load capacity: 30 t

Weight: 38 kg
Min./max. height: 150 mm / 409 mm
Chassis length: 326 mm

€ 1235,00

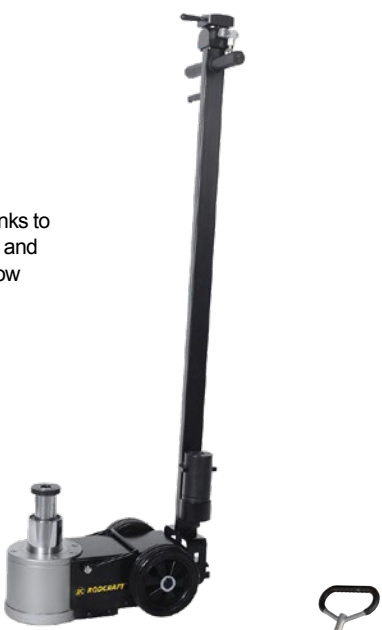

Hydraulic jack up to 50 t

Ideal for trucks and buses thanks to the high lifting capacity. Stable frame, easy maneuvering.

Model ATJ50-3

Item no.: 8951000270

Load capacity: 50 t

Weight: 73 kg
Min./max. height: 160 mm / 472 mm
Chassis length: 555 mm

€ 1795,00



Wheel dollies
Model RHW1
Item no.: 8951089091

- Assembly aid for various wheel types/wheel sizes
- Adjustable support arms (29-62 cm)
- Hand lever with adjustable length (3 positions)
- Stop rollers for rim
- Max. load 250 kg



€ 199,00

Wheel dollies
Model RG600
Item no.: 8951089045

Maximum load capacity 600 kg

- For tires up to 300 mm wide and with a maximum diameter of 650 mm
- Low weight of the gripper at only 18 kg



€ 185,00



Transmission jack

Model	GHN600	GHN1000
Item number	8951000448	8951000449
Capacity (kg)	600 kg	1,000 kg
Min. height (mm)	1,180 mm	1,180 mm
Max. height (mm)	2,000 mm	2,010 mm
Weight (kg)	36.9 kg	48.1 kg
Amount of hydraulic oil	0.91 l	1.32 l

- High security, stability and easy positioning.
- Chromed cylinder in oil bath
- Large foot pedal for stepless load lifting
- Dead man's control



€ 499,00

Workshop crane, up to 1 t

Model WK1000

Item no.: 8951000166

- Extra flat extension arms, only 90 mm high
- 3 positions for flexible adjustment (load dependent)
- 360° rotatable crane hook with safety device
- Foldable extension arms with safety bolts for space-saving storage
- 200° pivoting hand pump with double piston
- Lowering valve with dead man's control



€ 699,00

Hydraulic ram set 4t

Model HRS04

Item no.: 8951000124

€ 149,00

Hydraulic ram set – 10t

Model HRS10

Item no.: 8951000125



- Fully hydraulic ram set
- Possible uses: Press - expand - clamp
- Simple assembly thanks to threadless connections
- 17 piece set in plastic case for easy storage
- Individually shaped compartment for each part, so that the set remains complete
- Including full set of accessories

€ 359,00

Hydraulic ram set 20 t

Model HRS20

Item no.: 8951000126



Fully hydraulic ram set – 20 t, incl. accessories set.

- All accessories in steel with threaded connection
- 2-stage hand pump for 700 bar working pressure
- In 2 robust metal boxes
- Hydraulic cylinder with 130 mm lift
- Hose length 1,500 mm (pump/cylinder)

€ 999,00

Hydraulic ram set 10 t

Model RGS100

Item no.: 8951089054

- Easy to move with oil and acid resistant plastic wheels
- Strong 8" 10 t hydraulic piston
- Pulling arm can be tilted sideways by 45°
- Precise pump control for smaller or more complicated directional work
- PHP10 is an ideal complement to save time and reduce manual effort

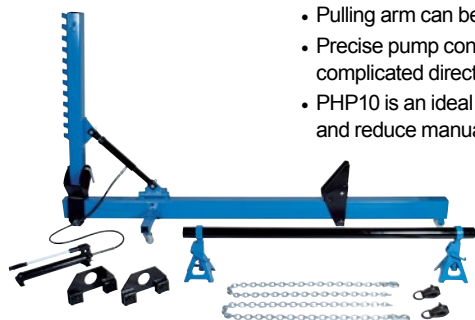

€ 1590,00

Pneumatic-hydraulic pump

Model PHP10

Item no.: 8951000136



- Can be used with the hydraulic cylinders HRS04, HRS10 and HRS20
- For convenient and energy-saving hand or foot operation
- Maximum hydraulic pressure of 700 bar

€ 299,00

Workshop presses

Hydraulic workshop presses are indispensable in the workshop and many industrial companies for special precision work, such as removing and replacing ball bearings, bending pipes or profiles or straightening bent parts. The professional presses can be bench mounted or installed on the floor with shims for perfect stability. Some of our hydraulic presses have various additional functions such as lateral cylinder adjustment, two speed levels - for fast approach and powerful pressing - and foot control.

New 2-speed automatic pump for WP15/WP20S/WP30P/WP50P
Easier to use, no need to change speed manually.

Model WP15
 Item no.: 8951000064



15 tons

€ 795,00

Model WP30P
 Item no.: 8951000071



30 tons

€ 1755,00

Model WP50P
 Item no.: 8951000072



50 tons

€ 3175,00

Model WP100P
 Item no.: 8951000171



100 tons

€ 7450,00

Model	WP15	WP30P	WP50P	WP100P
Item number	8951000064	8951000071	8951000072	8951000171
Capacity	15 t	30 t	50 t	100 t
Height	882 mm	1772 mm	1830 mm	1830 mm
Width	700 mm	795 mm	1030 mm	1200 mm
Weight	75.5 kg	167 kg	298 kg	766 kg
Hydraulic stroke	160 mm	160 mm	200 mm	300 mm

Punch set Model DS8

Item no.: 8955000050

- 8 mandrels (10, 12, 16, 18, 20, 22, 25, 30 mm)
- Quick-change mount
- Perforated sheet
- Bracket

€ 141,00





Quick-change mount with 8 mandrels suitable for Rodcraft workshop presses WP15, WP20S, WP30P, WP50P, WP75P and WP100P
 Allows quick mandrel changes and fits the piston of all workshop presses pictured above.

Plug nipples + quick couplings

	Item number	Designation	
	8951011809	Plug nipple with thread BSP 1/4" external thread	€ 2,00
	8951011810	Plug nipple with thread BSP 3/8" external thread	€ 2,00
	8951011811	Plug nipple with thread BSP 1/2" external thread	€ 3,00
	8951011812	Plug nipple with thread BSP 1/4" internal thread	€ 2,00
	8951011813	Plug nipple with thread BSP 3/8" internal thread	€ 2,00
	8951011814	Plug nipple with thread BSP 1/2" internal thread	€ 3,00
	8951011795	Nipple ISO7, 2 mm, for hoses 6-7 mm	€ 2,00
	8951011796	Nipple ISO7, 2 mm, for hoses 9 mm	€ 2,00
	8951011797	Nipple ISO7, 2 mm, for hoses 13 mm	€ 2,00
	8951011784	Quick coupling BSP 1/4" external thread	€ 6,00
	8951011785	Quick coupling BSP 3/8" external thread	€ 6,00
	8951011786	Quick coupling BSP 1/2" external thread	€ 6,00
	8951011787	Quick coupling BSP 1/4" internal thread	€ 6,00
	8951011788	Quick coupling BSP 3/8" internal thread	€ 6,00
	8951011789	Quick coupling BSP 1/2" internal thread	€ 6,00
	8951011790	Quick coupling for hoses 6-7 mm	€ 6,00
	8951011791	Quick coupling for hoses 9-10 mm	€ 6,00
	8951011792	Quick coupling for hoses 13 mm	€ 6,00
	8951011819	2-way distributor with quick coupling BSP 3/8" internal thread	€ 16,00
	8951011820	3-way distributor with quick coupling BSP 3/8" internal thread	€ 25,00

PE pneumatic air hose with coupling Model PE pneumatic air hose

	Item number	Designation	
	8951011842	PUR Spiral hose, 8mm inner diameter and 4m long EUR7,2 coupling and nipple connector	€ 56,00
	8951011843	PUR Spiral hose, 8mm inner diameter and 6m long EUR7,2 coupling and nipple connector	€ 52,00
	8951011844	Length 8 m, Internal diameter 8 mm, External diameter 10 mm, max. working pressure 15 bar	€ 74,00
	8951011845	Spiral hose 6,5mm inner diameter with 1/4" AG thread Lenght 6m made from polyurethane PUR	€ 40,00
	8951011846	Spiral hose 8mm inner diameter with 3/8" AG thread Lenght 6m made from polyurethane PUR	€ 55,00
	8951011847	Spiral hose 8mm inner diameter with 3/8" AG thread Lenght 4m made from polyurethane PUR	€ 48,00
	8951011848	Spiral hose 8mm inner diameter with 3/8" AG thread Lenght 8m made from polyurethane PUR	€ 65,00

RODCRAFT FRL maintenance units: Cleaner air, full power

With the RODCRAFT maintenance unit, you extend the service life of your compressed air tools and reduce the energy requirement. Your tools are automatically set to the optimum oil quantity supplied and the filter provides protection against dirt and water

€ 107,00

Maintenance unit –
connections 1/2"

Item no.: 8951000164

€ 107,00

Maintenance unit –
connection 1/4" BSP

Item no.: 8951000162

- Stable aluminum housing with composite containers.
- 5-Micron filter
- Semi-automatic manual drain
- Max. inlet pressure 15 bar
- Max. air passage 2,080 l/min



Hose reel

With length adjustment, ratchet lock, swiveling wall bracket and all-round movable air connection

High-quality hose for all applications, lighter and more flexible than rubber. Latch spring locks the hose after unrolling and pulls it effortlessly with return power on again.

Rubber protection protects against stress on the crimp connections.

Drum spring: up to 20,000 - 25,000 cycles for excellent durability. Movable retraining ball allows adjustment of the minimum hose length.



Model	SAR21	SAR22	SAR31	SAR32
Item number	8951000148	8951000149	8951000150	8951000151
Length	10 m	16 m	10 m	160 m
Internal diameter	8 mm	10 mm	8 mm	10 mm
Thread size	1/4" BSP	3/8" BSP	1/4" BSP	3/8" BSP
Hose material	Polyurethane			

€ 169,00 € 261,00 € 231,00 € 331,00

Device oiler Model G1K

Item no.: 8951011851



Small oiler with a volume of 4 ml that is attached directly to the tool. 1/4" thread

€ 8,00

Air oil RCA1000

Item no.: 8955000117

For the lubrication of pneumatic tools. Contains additives that constantly maintain the protective film against rust and corrosion

Air oil, 1,000 ml



- Very good flow properties at low temperatures
- Very good protection against corrosion
- High pressure and impact resistant
- Non-toxic

€ 25,00

The Rodcraft brand stands for high-quality products and services. Since its founding in 1974, Rodcraft has continuously developed into a globally leading brand for pneumatic tools and workshop equipment, with a focus on automotive service and industrial maintenance.



© 2026 Rodcraft. Subject to technical modifications.

RC RODCRAFT®

Changes, misprints and errors reserved
Prices on request, please contact your
preferred retailer or visit us at
www.rodcraft.com

Desoutter GmbH – Markenvertrieb Rodcraft
Maximilian-Fratscher-Strasse 4 | 63500 Seligenstadt | Deutschland